

VÁLVULAS SERIE 70 NEUMÁTICAS

DATOS TÉCNICOS	1/8"	1/4"	1/2"
Presión de trabajo	Vacío ÷ 10 bar		
Presión mínima de trabajo			
• Monoestable	2.5 bar		
• Biestable	1 bar		
Temperatura de trabajo	-10° ÷ +60°C		
Diámetro nominal	5 mm	7.5 mm	15 mm
Conductancia C	121.43 NI/min	264.26 NI/min	971.43 NI/min
Relación crítica b	0.32 bar/bar	0.27 bar/bar	0.43 bar/bar
Capacidad a 6 bar ΔP 0.5 bar	400 NI/min	750 NI/min	3200 NI/min
Capacidad a 6 bar ΔP 1 bar	550 NI/min	1100 NI/min	4600 NI/min
TRA/TRR monoestable a 6 bar	6ms/15ms	7ms/15ms	16ms/46ms
TRA/TRR biestable a 6 bar	7ms/7ms	7ms/7ms	16ms/16ms



CLAVES DE CODIFICACIÓN

P	N	V	2	3	P	N	S	N	C
FAMILIA		DIMENSIÓN	FUNCIÓN		ACCION. 14		ACCION. 12	OTRAS DESCRIPCIONES	
PNV	Neumáticas	2 1/8" 3 1/4" 4 1/2"	3 3/2 5 5/2 6 5/3		PN	Neumático	S Resorte mecánico B Biestable bidireccional D Diferencial O Estable para 5/3 A Resorte neumomecánico*	OO 5/2 NC Norm. cerrada NO Norm. abierta CC Centros cerrados OC Centros abiertos PC Centros en pres.	

VÁLVULAS SERIE 70 1/8" NEUMÁTICAS

MONOESTABLE 3/2 NO 1/8"

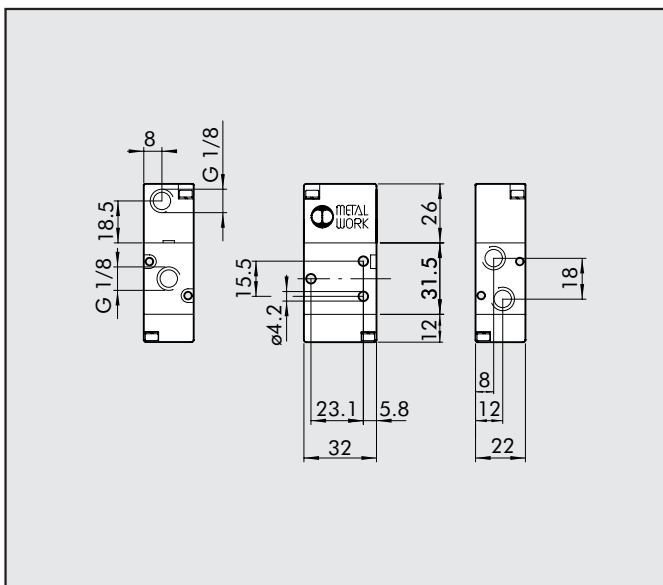

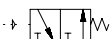
Símbolo	Referencia	Código	Peso [g]
	PNV 23 PNS NO	7010010400	82

MONOESTABLE 3/2 NC 1/8"

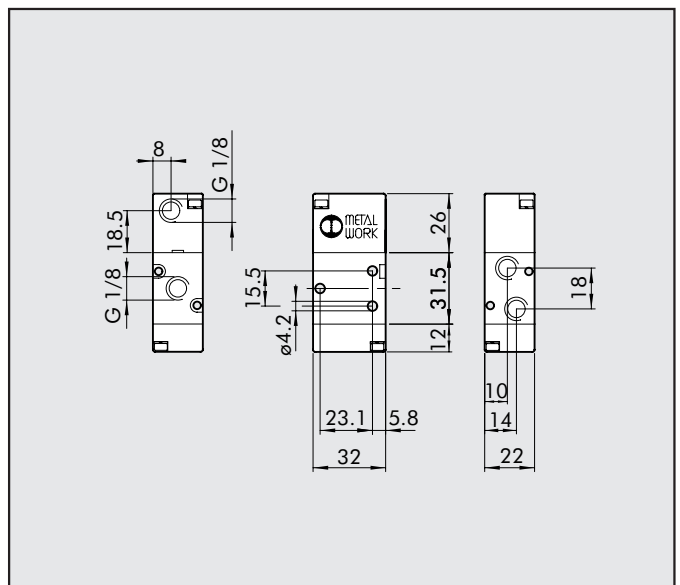

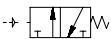
Símbolo	Referencia	Código	Peso [g]
	PNV 23 PNS NC	7010010200	82

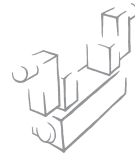

MONOESTABLE 5/2 1/8"

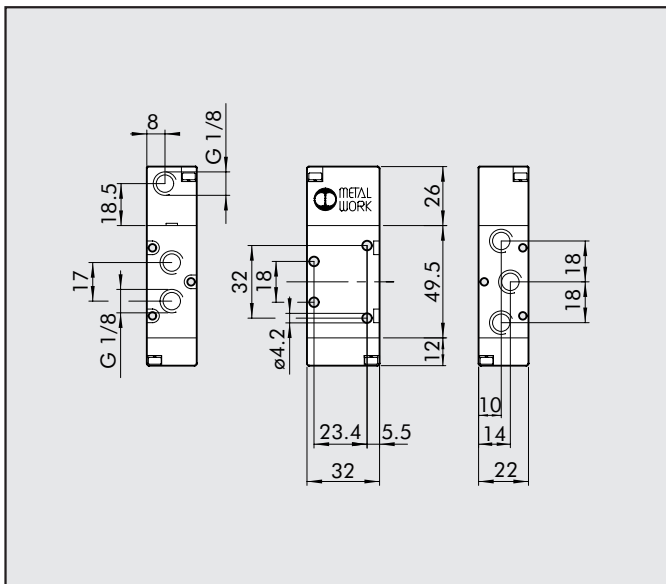

Símbolo	Referencia	Código	Peso [g]
→ W	PNV 25 PNS OO	7010011100	108

BIESTABLE 5/2 1/8"

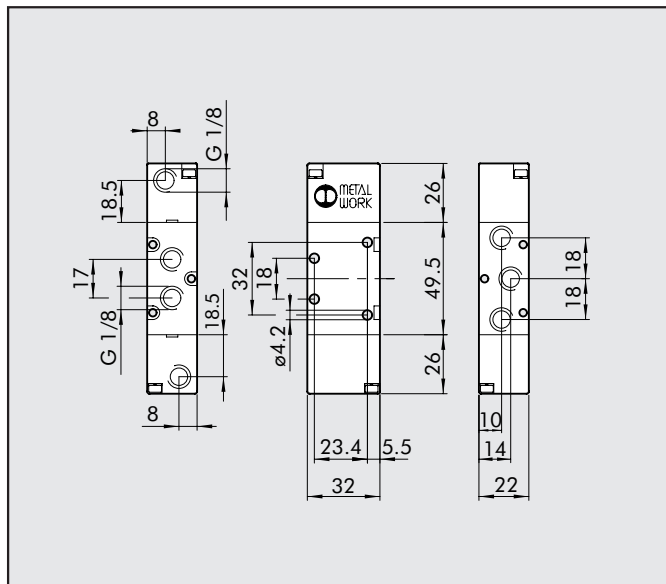

Símbolo	Referencia	Código	Peso [g]
→ W ←	PNV 25 PNB OO	7010011200	122
→ W ←	PNV 25 PND OO	7010011300	128

BIESTABLE 3/2 1/8"

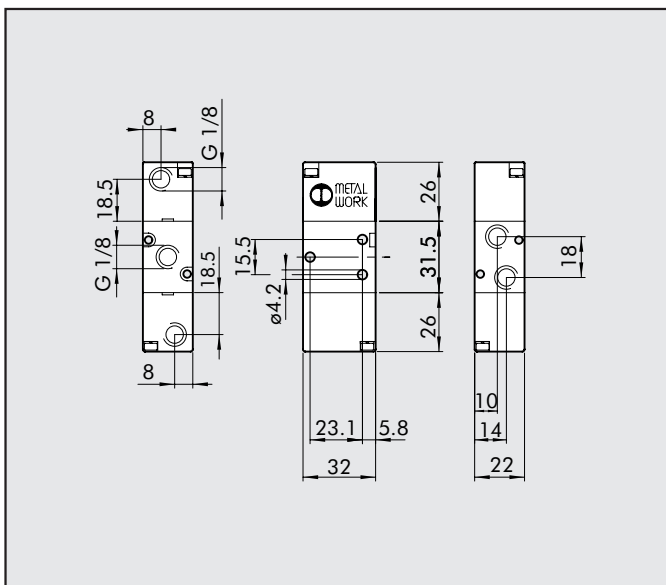

Símbolo	Referencia	Código	Peso [g]
→ W ←	PNV 23 PNB OO	7010010100	96

MONOESTABLE 5/3 1/8"

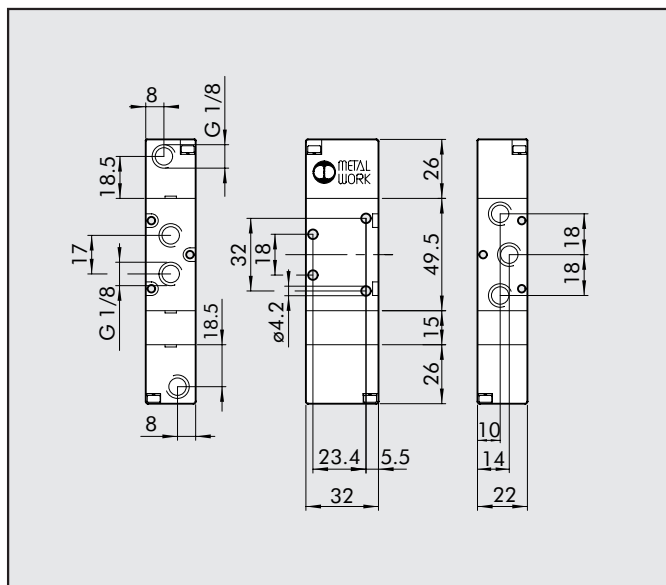

Símbolo	Referencia	Código	Peso [g]
→ W ←	PNV 26 PNS CC	7010012100	150
→ W ←	PNV 26 PNS OC	7010012200	150
→ W ←	PNV 26 PNS PC	7010012300	150

VÁLVULAS SERIE 70 1/4" NEUMÁTICAS

MONOESTABLE 3/2 NO 1/4"

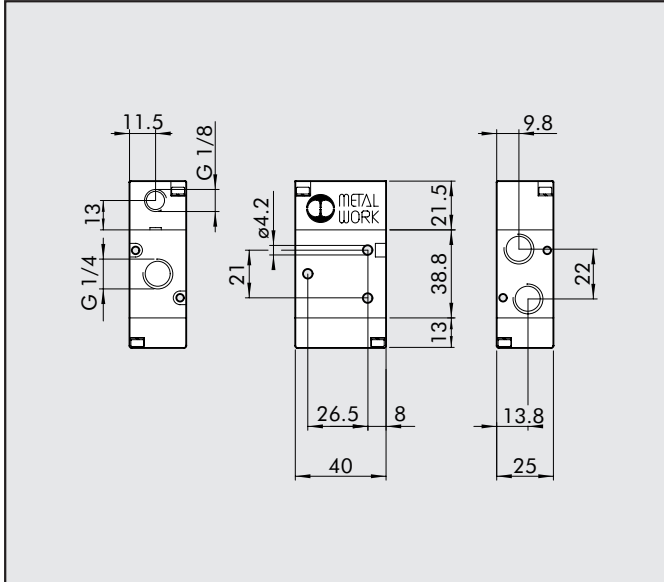

Símbolo	Referencia	Código	Peso [g]
	PNV 33 PNS NO	7020010400	124

MONOESTABLE 3/2 NC 1/4"

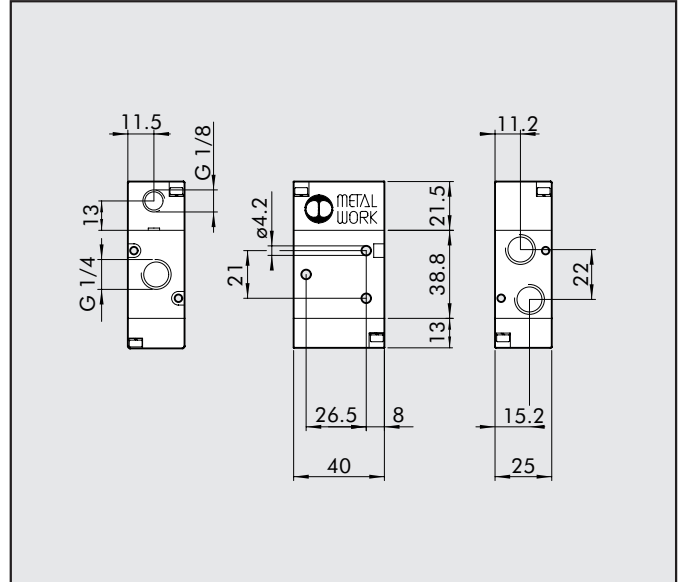

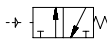
Símbolo	Referencia	Código	Peso [g]
	PNV 33 PNS NC	7020010200	122

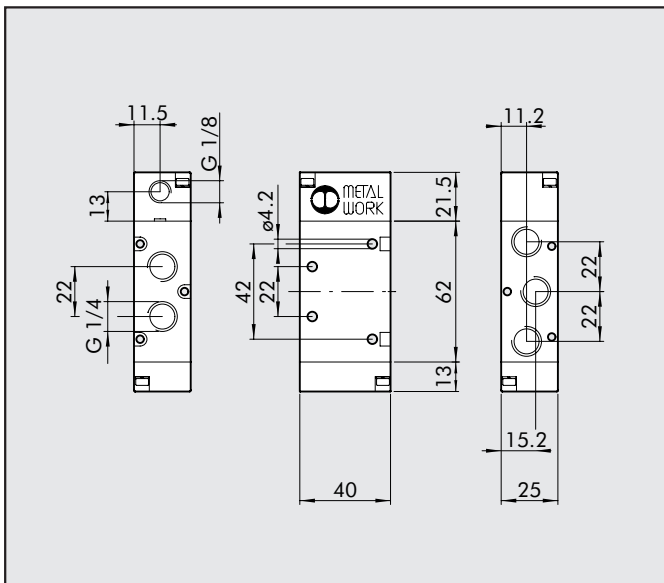

MONOESTABLE 5/2 1/4"

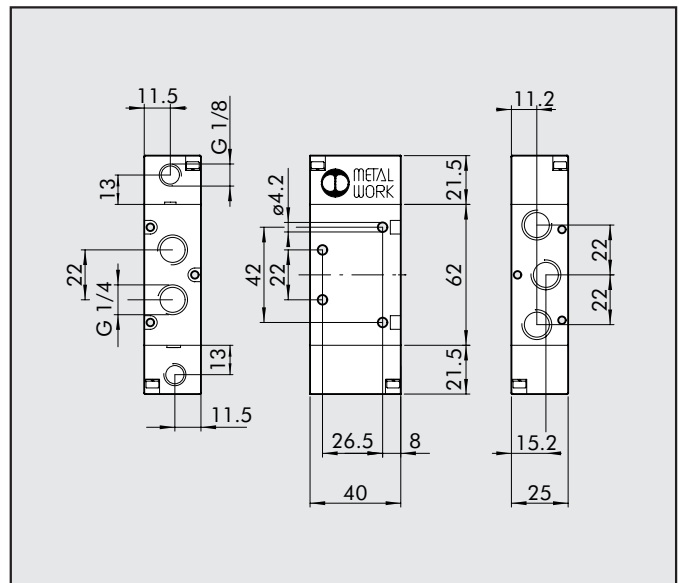

Símbolo	Referencia	Código	Peso [g]
	PNV 35 PNS OO	7020011100	174

BIESTABLE 5/2 1/4"



Símbolo	Referencia	Código	Peso [g]
	PNV 35 PNB OO	7020011200	174
	PNV 35 PND OO	7020011300	198

VÁLVULAS SERIE 70 1/2" NEUMÁTICAS

MONOESTABLE 3/2 NO 1/2"

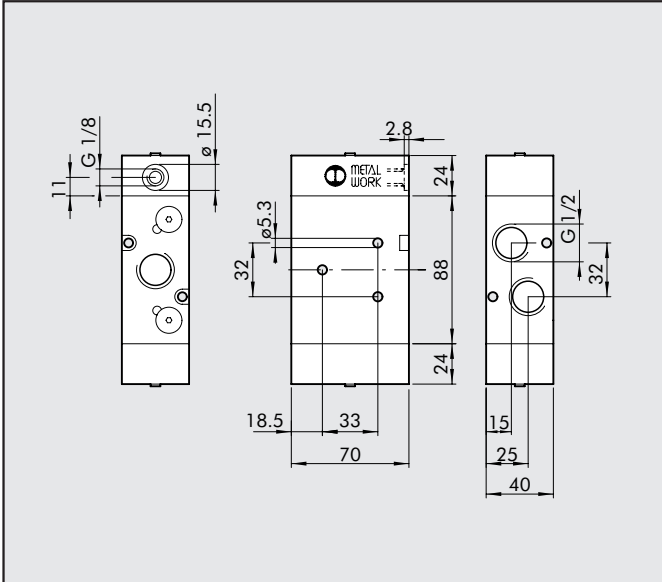

Símbolo	Referencia	Código	Peso [g]
	PNV 43 PNS NO	7030010400	905

MONOESTABLE 3/2 NC 1/2"

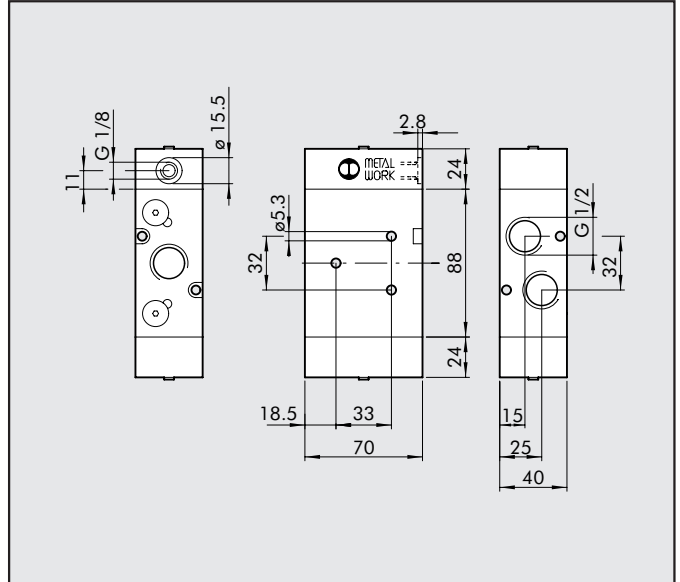

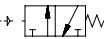
Símbolo	Referencia	Código	Peso [g]
	PNV 43 PNS NC	7030010200	905

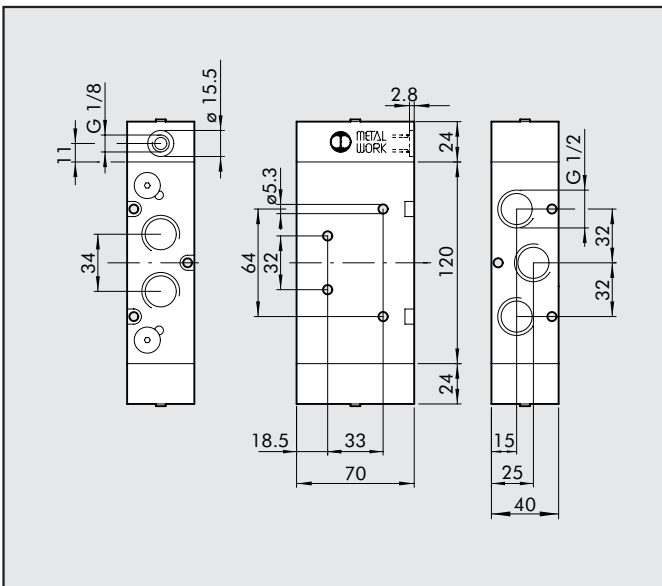

MONOESTABLE 5/2 1/2"

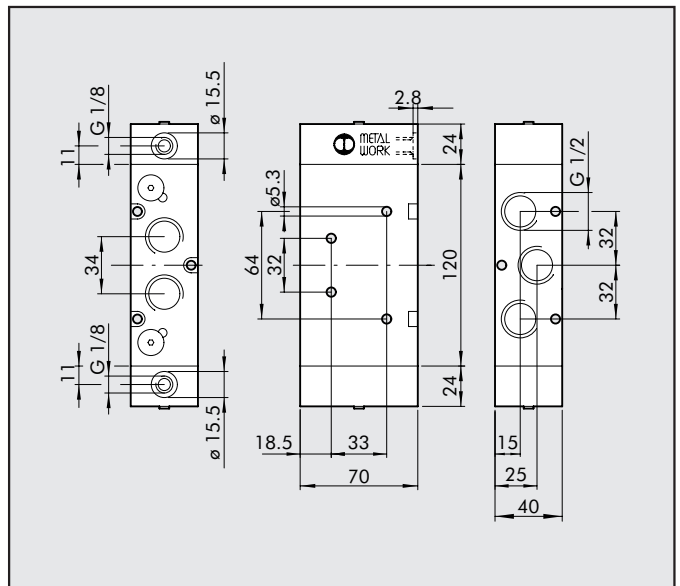

Símbolo	Referencia	Código	Peso [g]
	PNV 45 PNS OO	7030011100	1090

BIESTABLE 5/2 1/2"



Símbolo	Referencia	Código	Peso [g]
	PNV 45 PNB OO	7030011200	1077
	PNV 45 PND OO	7030011300	1090

